

Power



File: power.kicad_sch

FPGA



File: fpga.kicad_sch

FPGA{C[0..19]}
 FPGA{D[0..7]}
 FPGA{A[0..15]}
 {D_DIR D_OE_N A_DIR A_OE_N}

level shifters

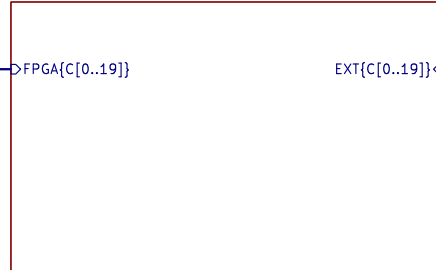

File: level_shifters.kicad_sch

Bus drivers

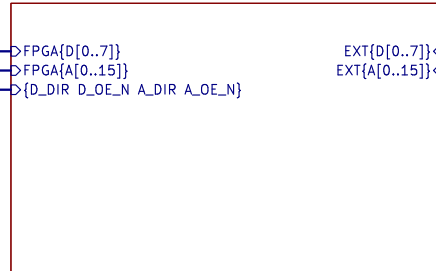

File: bus_drivers.kicad_sch

FPGA{C[0..19]}
 FPGA{D[0..7]}
 FPGA{A[0..15]}
 {D_DIR D_OE_N A_DIR A_OE_N}

FPGA{C[0..19]}
 EXT{C[0..19]}

FPGA{D[0..7]}
 FPGA{A[0..15]}
 {D_DIR D_OE_N A_DIR A_OE_N}

FPGA{D[0..7]}
 FPGA{A[0..15]}
 {D_DIR D_OE_N A_DIR A_OE_N}

EXT{D[0..7]}
 EXT{A[0..15]}

antic_pins

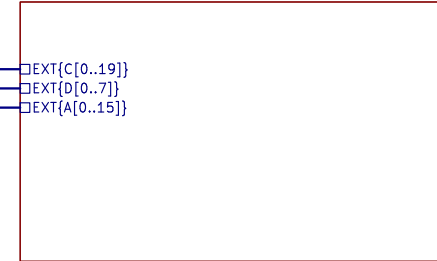

File: antic_pins.kicad_sch

EXT{C[0..19]}
 EXT{D[0..7]}
 EXT{A[0..15]}

Sheet: /
 File: fxantic2.kicad_sch

Title:

Size: A4 Date:

KiCad E.D.A. 9.0.1

Rev:

Id: 1/6

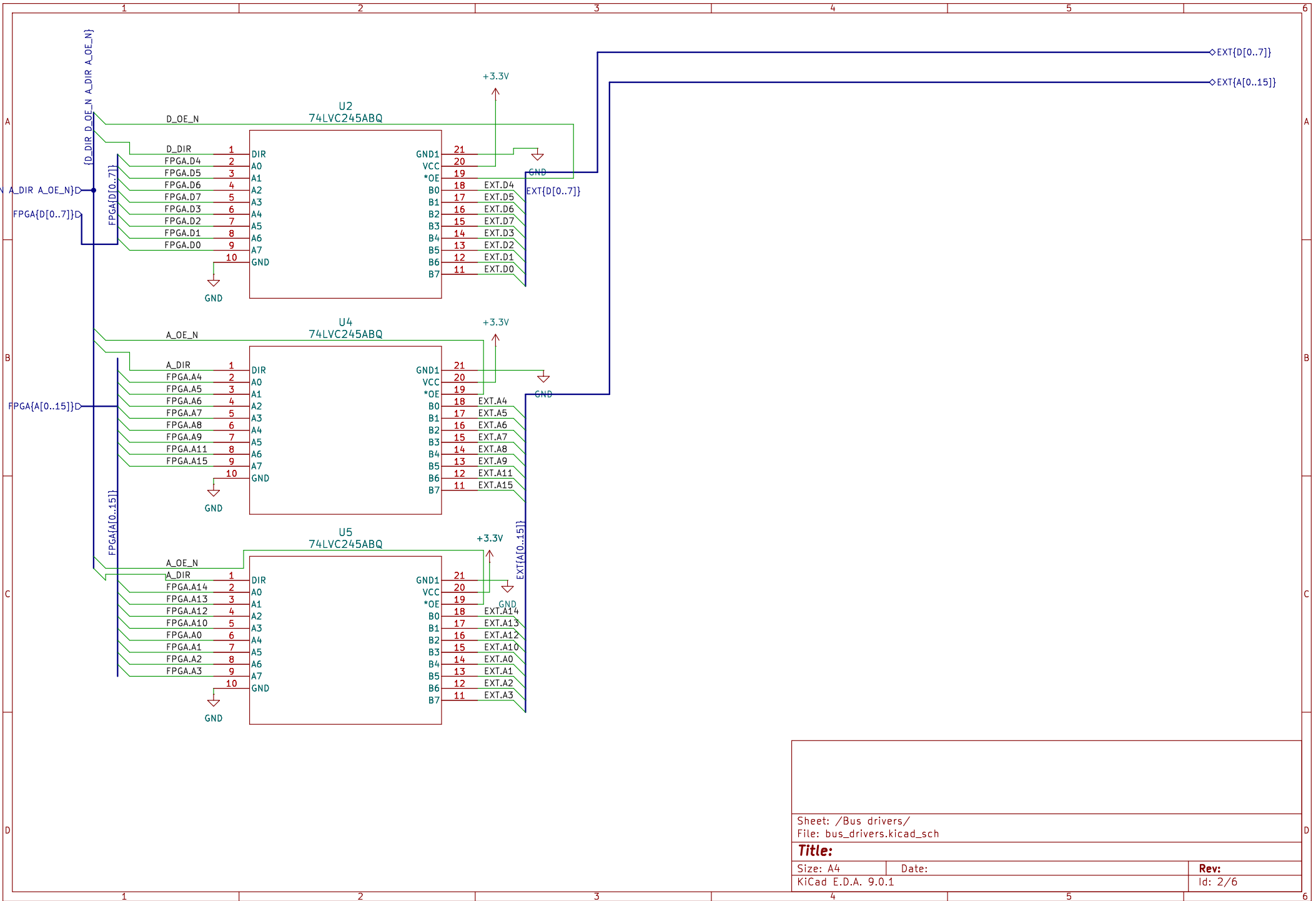

Sheet: /Bus drivers/
 File: bus_drivers.kicad_sch

Title:

Size: A4
 KiCad E.D.A. 9.0.1

Date:

Rev:
 Id: 2/6

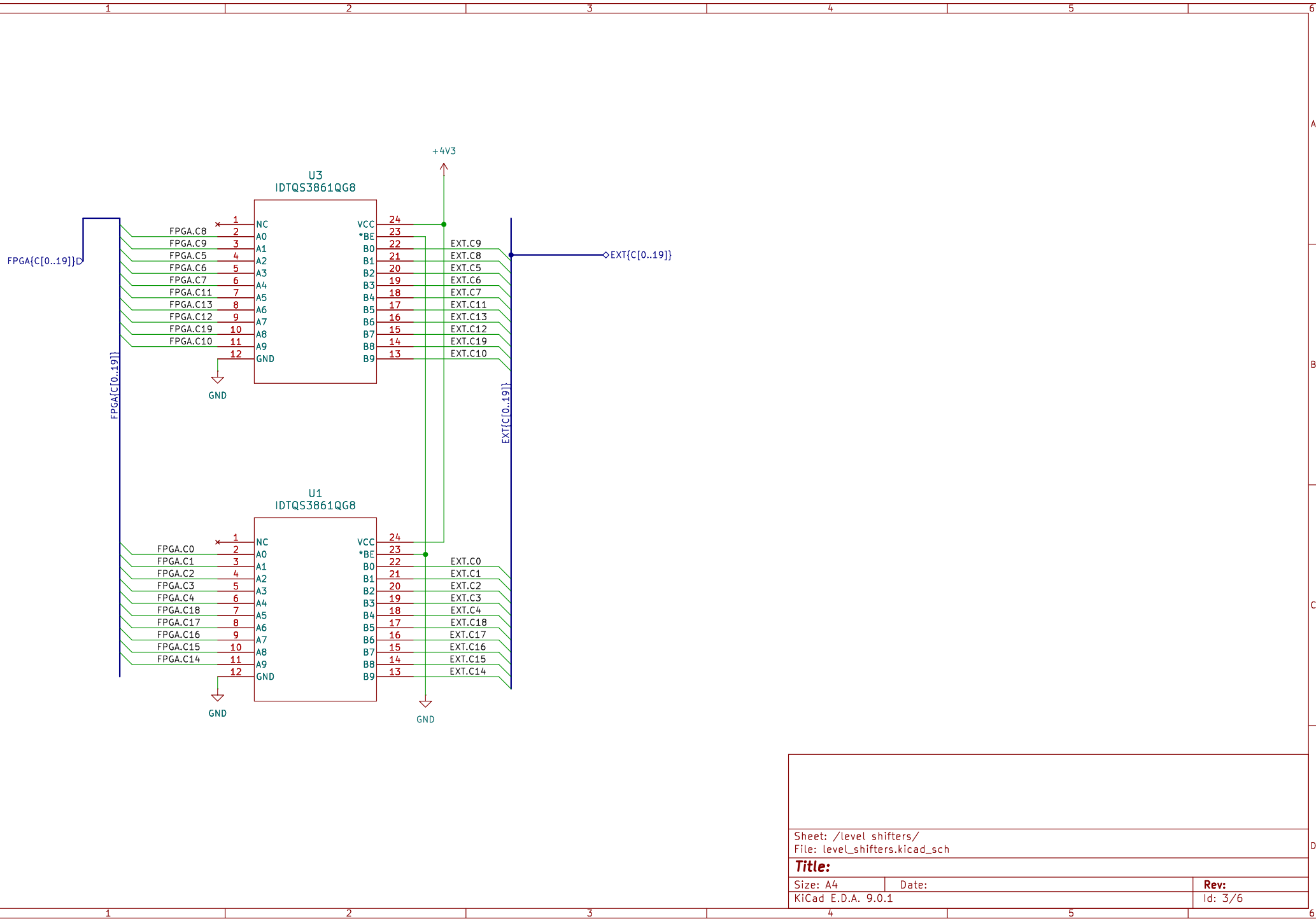

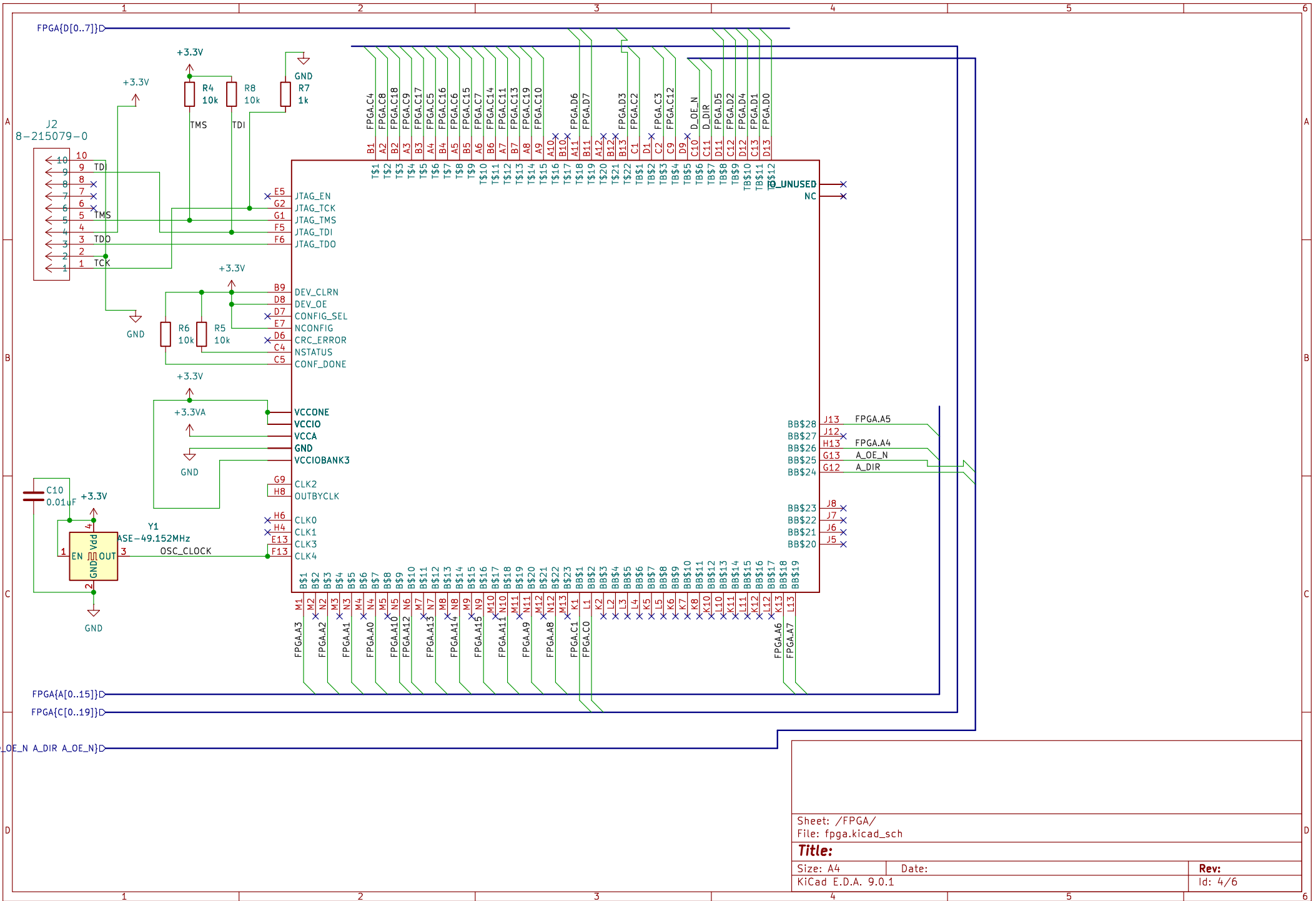

Sheet: /FPGA/
 File: fpga.kicad_sch

Title:

Size: A4
 KiCad E.D.A. 9.0.1

Date:

Rev:

Id: 4/6

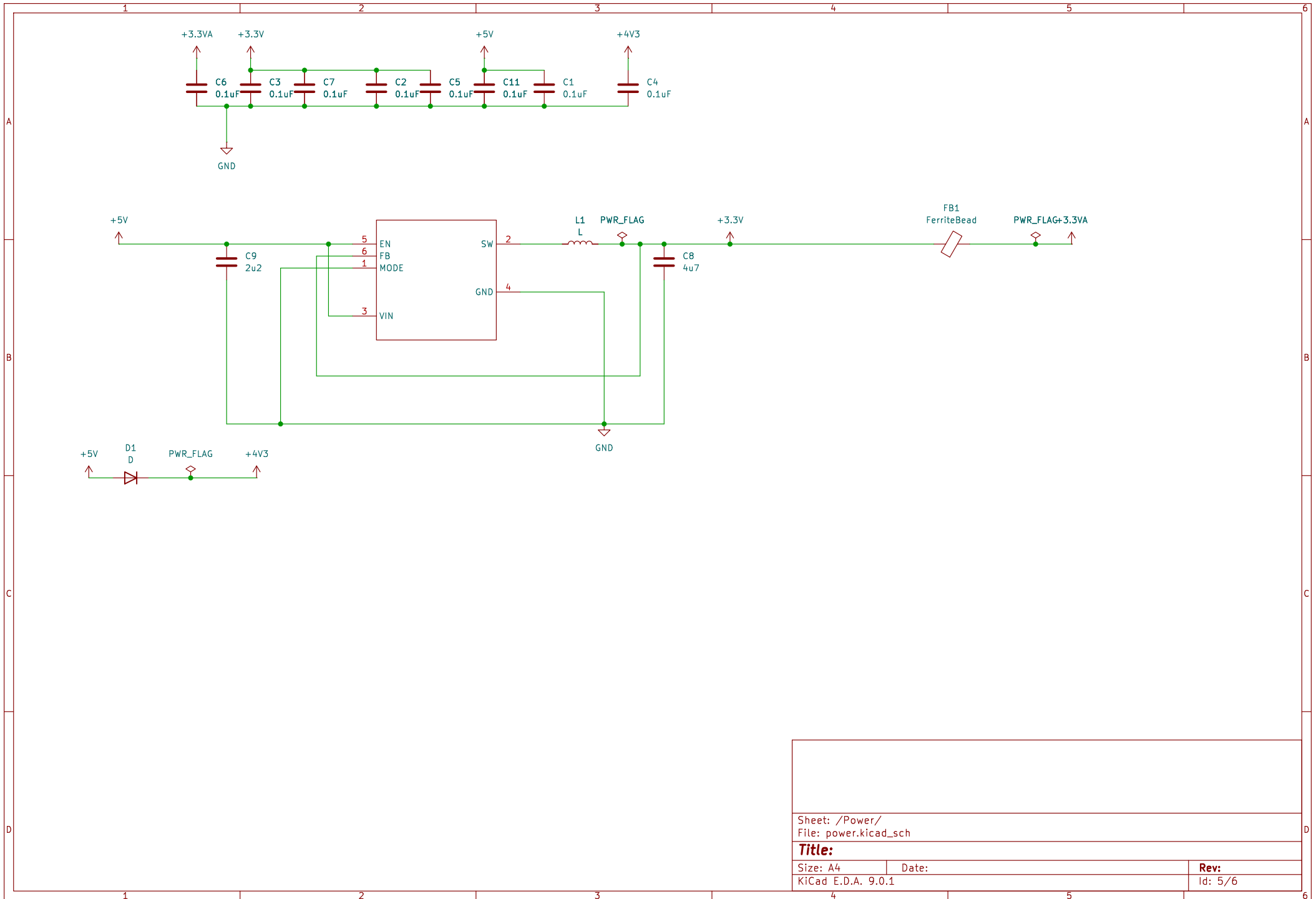

Sheet: /Power/
 File: power.kicad_sch

Title:

Size: A4
 KiCad E.D.A. 9.0.1

Date:

Rev:
 Id: 5/6

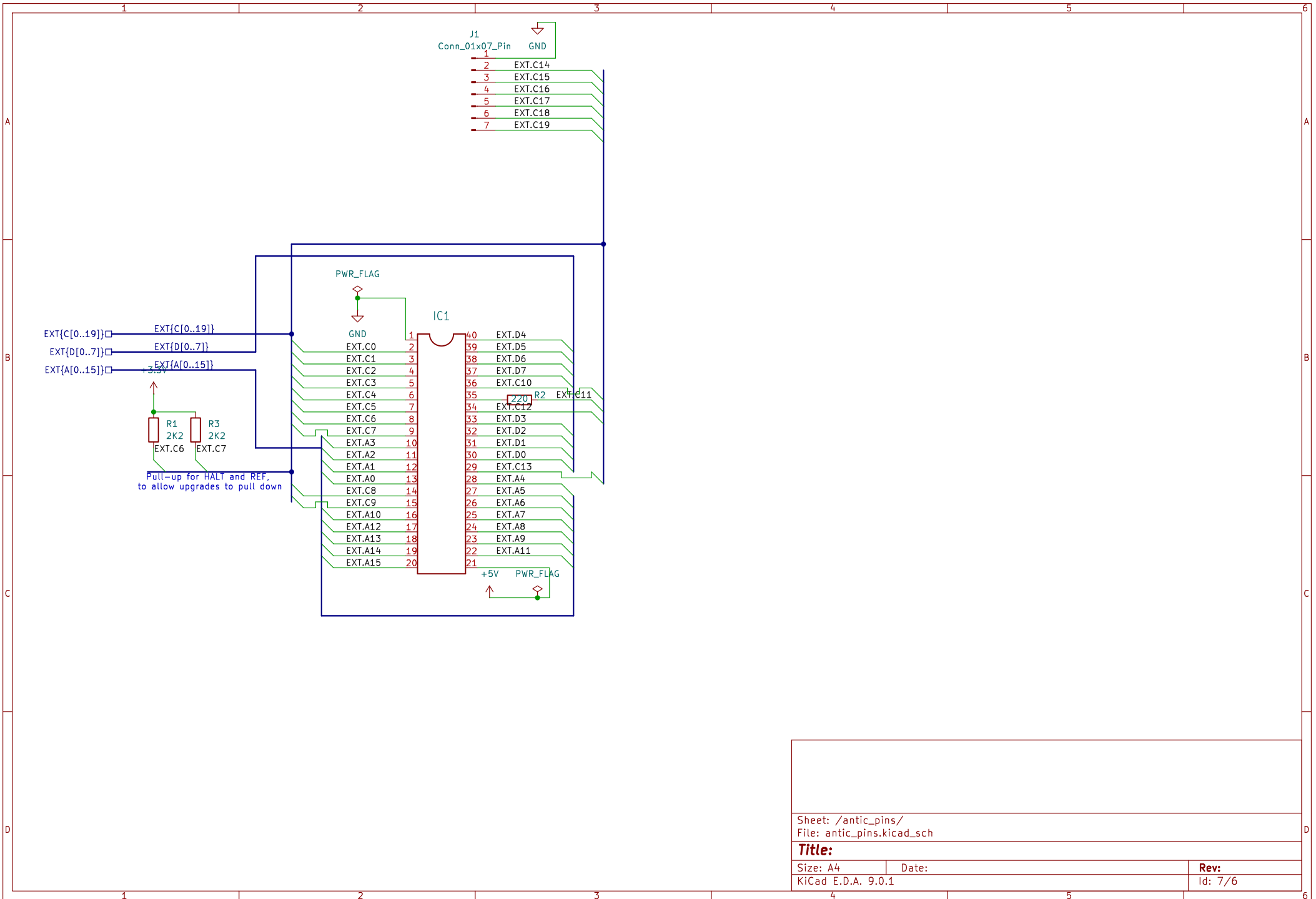

Sheet: /antic_pins/
 File: antic_pins.kicad_sch

Title:

Size: A4
 KiCad E.D.A. 9.0.1

Date:

Rev:

Id: 7/6